

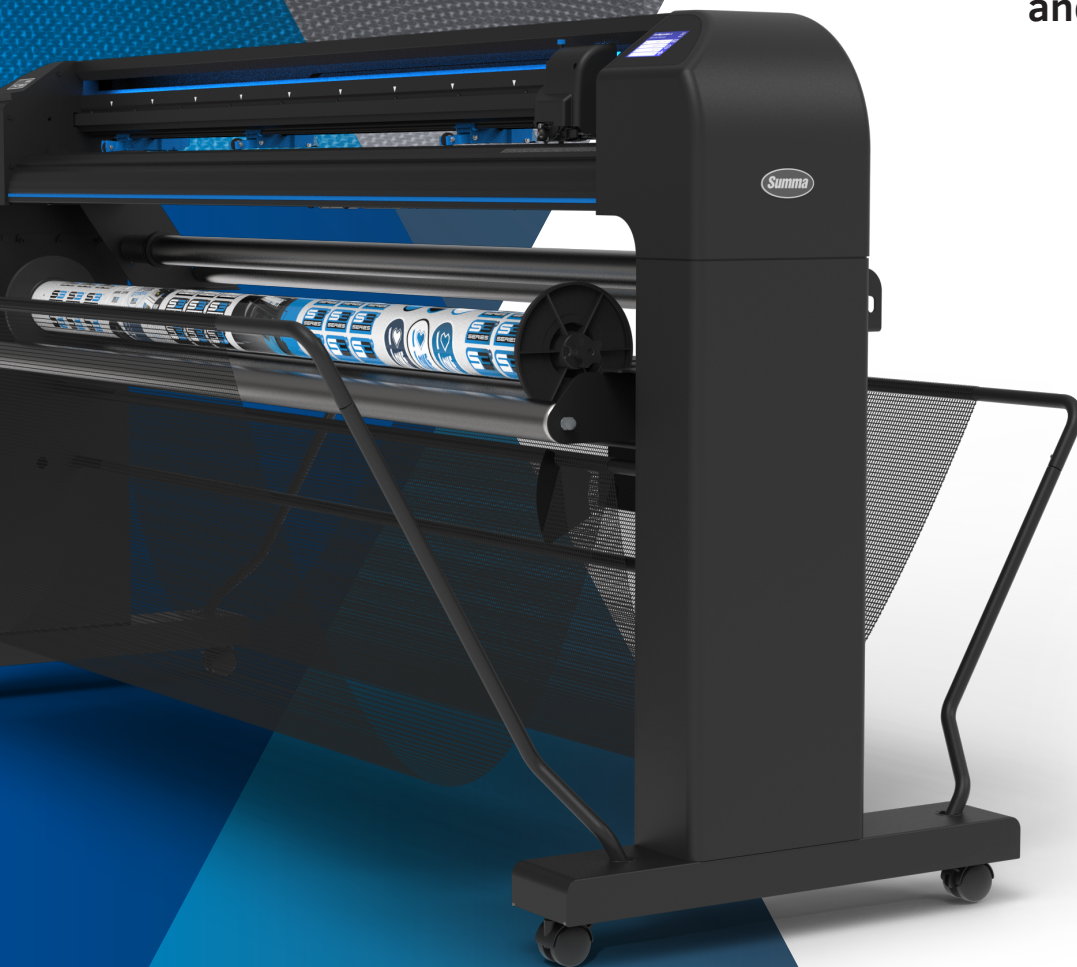

SUMMA ROLL CUTTERS

S One | S Class 3 Series

**World-renowned vinyl
and contour cutters**



www.summa.com | [#SummaFinish](https://twitter.com/SummaFinish)

ABOUT SUMMA

Summa is a manufacturer of innovative cutting equipment that helps companies and people to finish their applications to the highest standards. Delivering outstanding quality conforming to these high standards, has secured the Summa reputation for legendary performance.

Companies from all over the world use Summa cutting solutions for products in the printing, signage, display, apparel, and packaging industry. With the cutting solutions from Summa, your business is future-proof for many years to come.

www.summa.com | [#SummaFinish](https://twitter.com/SummaFinish)

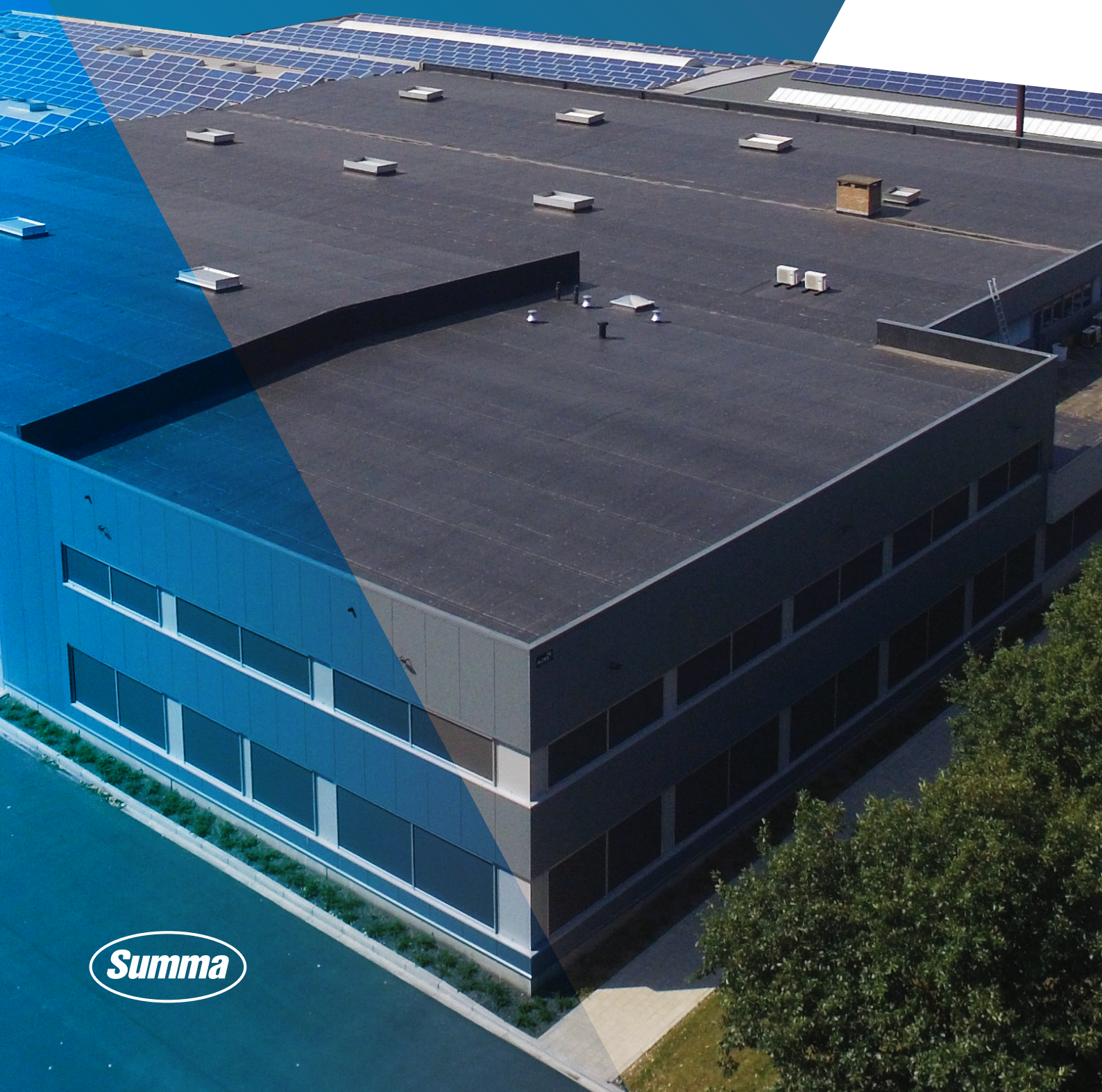

About Summa **02**

Introduction of Summa Roll-Fed Cutters **04**

The renowned roll-fed cutters from Summa are designed to deliver high-end contour cutting accuracy for printed graphics on vinyl and soft sheet materials.

Drag Knife Technology	05
Tangential Knife Technology	06
Advanced Cutting Features	07
Registration Marks (OPOS Contour Cutting)	08
Twin Workflow – F Series	09

Summa S One Cutters **10**

The S One Series is the next step in growing your business, designed with a focus on ergonomics and simplicity in usage. Discover the models and their innovative and future-proof features.

Models	12
Tray One Sheet Feeder	16
Technical Specifications	17

Summa S Class 3 Cutters **18**

Featuring first-class engineering and advanced cutting technology, the S Class 3 Series is an excellent choice for professional users who require performance, precision and versatility.

Models	20
Cutting Technologies	24
Features & Media Handling	26
Technical Specifications	27

Summa GoSign Software **28**

Powerful, in-house developed software tailored to the Summa roll cutter series.

Order Codes **31**

SUMMA ROLL-FED CUTTERS, MADE TO LAST

Summa offers two advanced roll-fed cutting product lines based on over 30 years of experience in building the world's very best cutting plotters: the Summa S One Series and Summa S Class 3 Series.

Both series are designed on a foundation of rock-solid reliability and outstanding expertise. They feature the highest quality engineering and most advanced cutting technology to deliver high-end contour cutting accuracy for printed graphics.

A Summa roll-fed cutter is your first choice roll cutter where value and reliability are top of mind. Equipped with smart technologies to help you finish your jobs flawlessly. Enjoy the easy-to-use features to tailor your cutting workflow most efficiently.



Sign & Display

The Summa roll cutter series are designed to deliver a wide range of applications for the Sign & Display market. Achieve perfectly cut stickers, traffic signs, billboards, and so on, with the S Class 3 and S One roll cutters now and for many years to come!

The world of Sign and Display is broad and versatile. Summa vinyl cutting solutions can optimize your print & cut workflow, meet your customers' deadlines, and deliver perfectly finished end-products.

- (One-off) Stickers
- Labels
- Window Stickers
- Vehicle lettering and graphics
- Window lettering
- Flock/Flex templates
- Intricate small letters/designs
- Technical textiles

Drag Knife Technology

Drag or swivel technique is the most used technique in the market to process designs for billboards, light boxes, window graphics, and so on. However, depending on the media thickness, some distortions or deviations in the corners may occur by using this technique.

This is why Summa drag knife cutters include enhanced methods to avoid such distortions and optimize the drag movement in order to obtain the best possible cutting quality.

Drag Movement

1. The drag knife stops cutting before entering a corner.
2. The eccentric blade is rotated by performing a drag movement to the desired angle, never leaving the media.
3. Once the drag-movement is completed, the corner cutting continues.

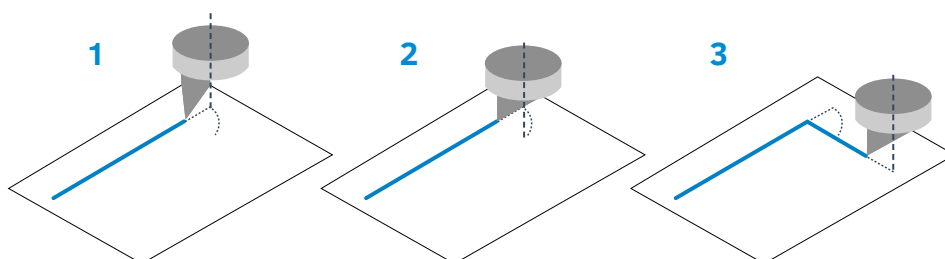

Tangential Knife Technology

Summa's True Tangential cutting technology delivers ultimate cutting precision and performance. The motorised knife is ideal for cutting large signs, stickers, small texts and details. This technology is available on the Summa S Class 3 T and TC Series. Coupled with an astonishing array of innovations and built-in capabilities, this series offers you the best there is in roll cutting.

Tangential Cutting Head | S Class 3 T(C) Series

Featuring computer-controlled blade rotation and up to 1000 grams of cutting force, Summa's T Series combines the precision of a flatbed cutter with the ease and speed of a roll-fed cutter by using our legendary True Tangential cutting head. The T Series cuts with more force and accuracy than any other cutter in its class.

KEY STRENGTHS

- Technology unique to Summa
- Motorised knife and accurate depth control
- Perfect to cut Thick, Thin, and Tough material
- Ultimate cutting precision in corners and the tiniest of details

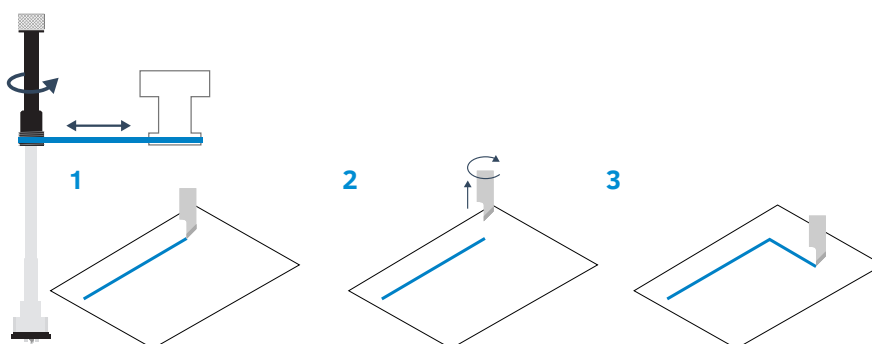
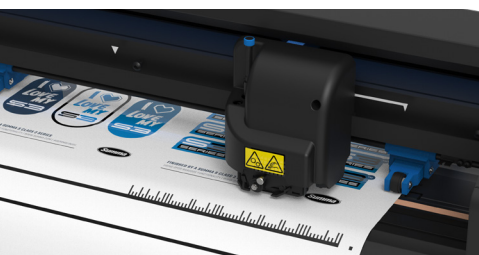

Tangential Movement

1. The tangential knife stops cutting right before a corner.
2. A motor lifts and reorients the blade.
3. Once the blade has reached the desired angle, it is lowered and continues to cut the corner

Advanced Cutting Features

Internal Intelligence

Summa cutters are loaded with intelligent routines, optimising the cutting data. All Summa cutters use an advanced vector look-ahead technology that cuts complex images and lettering with improved efficiency. The cutting time is reduced considerably, curves are smoother, and the motors are less taxed, which increases the lifetime of the cutter.

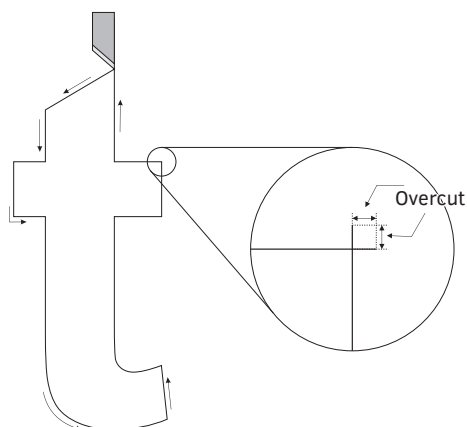

OverCut

OverCut extends the vector at the beginning and at the end of a vector. This ensures the design is cut through completely. Without the OverCut function, the cut line may not be completely closed, causing difficulties when weeding.

OptiCut

OptiCut, a function specifically developed for drag knife cutters, simulates tangential cutting. Due to performance of complex movements, the OptiCut feature compensates for changes in the blade offset, caused by wear and tear. The OptiCut feature ensures the knife is orientated correctly. This revolutionary technology gives you optimal quality during your blade's lifetime.

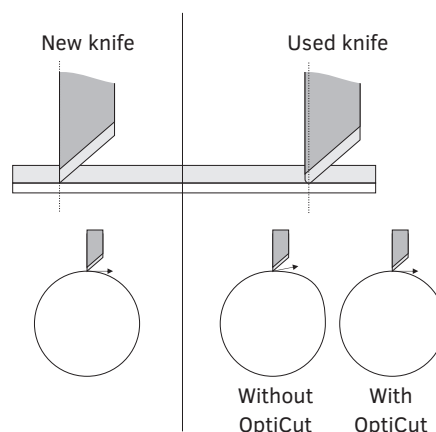

Summa FlexCut

Summa's FlexCut feature enables you to cut simple designs completely through the material. Alternately, one length is cut completely through the material, and one length is cut halfway through. This way, a tear-off line is created, ensuring the material keeps a certain rigidity during transport through the Summa cutter, while remaining easy to remove from the design afterwards.



Material Transport

Material transport is probably one of the most intricate aspects when cutting vinyl. The slightest error can result in material waste, loss of time, and operator frustrations. Summa offers an exquisite tracking system and extensive range of features to ensure your Summa S One or S Class 3 cutter performs perfectly and flawlessly.

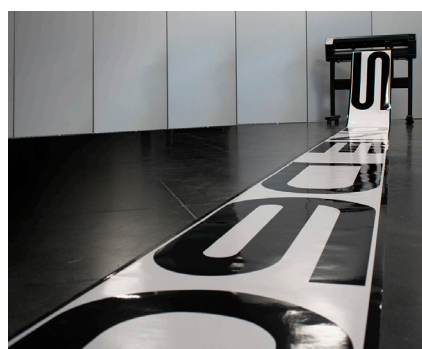

Registration Marks (OPOS Contour Cutting)

Summa's automated contour alignment system OPOS stands for Optical Positioning System. The OPOS sensor registers printed squares around the graphic. This allows OPOS to determine the exact position of the printed graphic and enables you to die-cut valuable printed and laminated vinyl graphics with complete confidence and ease.

OPOS X

The OPOS X feature, available on all Summa models, uses a sensor to automatically search for the cross marks. The possibility to use multiple cross marks is a unique OPOS feature and guarantees the best possible accuracy. The OPOS X sensor even detects registration marks through dense laminated graphics with uneven texture and brings contour cutting to a much higher level.

OPOS XY / OPOS XY2

The OPOS XY alignment method allows measuring a line across the print width, in addition to the OPOS marks. This will automatically adjust media curvature or deformation across the width of the print.

The OPOS XY2 alignment method adds an extra measuring line at the end of the print, allowing you to compensate for any changes in print curvature between start and finish of your print job.

OPOS Barcode

The barcode reading functionality is a productivity tool. Multiple jobs can thus be processed without operator intervention. It eliminates the risk of printing the wrong data. The OPOS X sensor reads the barcode and sends the correct job number to the computer. The computer then provides the matching cutting information, which is immediately processed by the cutter. When the job is finished, the cutter automatically starts looking for the next job and its barcode.

OPOS Xtra

The next evolution in OPOS is OPOS Xtra. This alignment mode is designed to handle irregular material deformation over the length of the print by adding additional XY lines between the designs. This increases the alignment accuracy for smaller stickers.

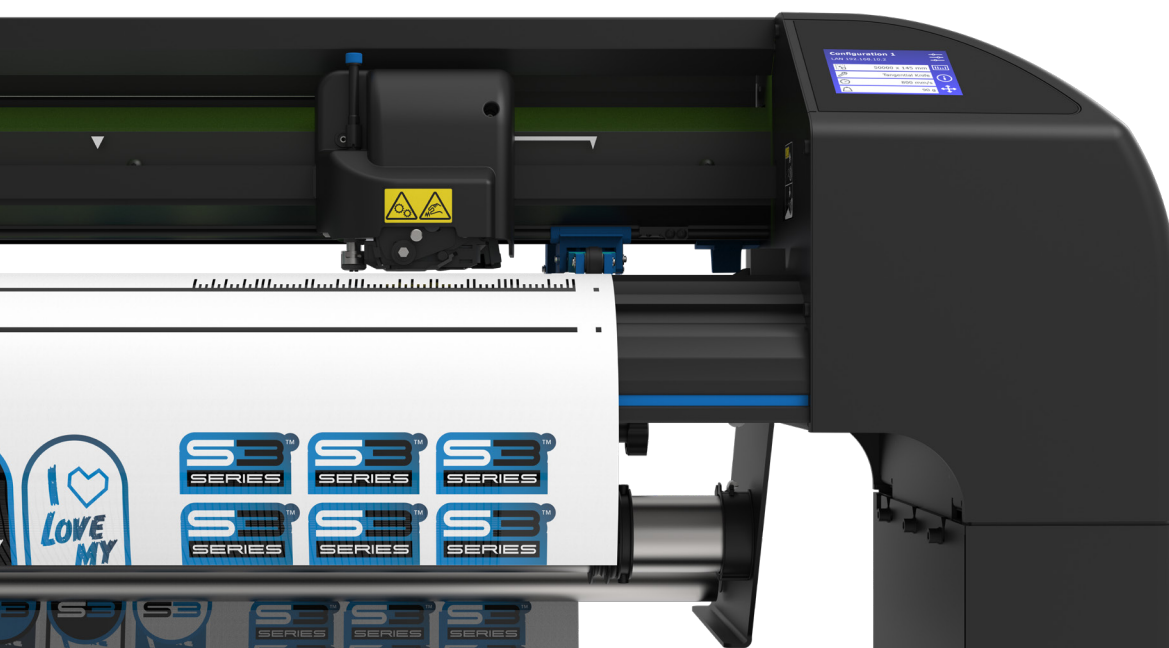
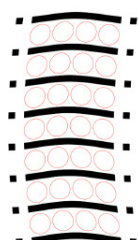
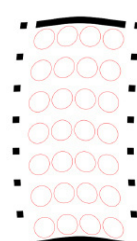
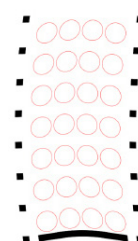
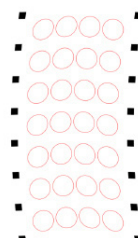

OPOS alignment systems are available for all models



“Thanks to the use of the Summa vinyl cutter, we are able to create new opportunities and solutions, such as the processing of nautic sails. This particular substrate is a special textile, which is very hard and rigid to print and cut. In the past, we didn't succeed in processing them properly, but thanks to Summa's expertise – in both product and service – we are now able to deliver these sails with great finishing results.”

/ Industria Graphica FG about investing in a Summa roll-fed cutter

Twin Workflow with F Series Flatbed Cutters

To maximise productivity and flexibility in your finishing workflow, you can use the Twin Workflow. It combines the strength of a Summa roll cutter with an F Series flatbed cutter, meaning you can kiss-cut on the roll cutter and cut through on the F Series flatbed cutter.

The Twin Workflow has been developed for users that want to optimise the use of their equipment. By using one of these workflows, productivity, and performance will be brought to a higher level. The smooth integration of the cutters into existing workflows will further contribute to the customer's Productivity, Performance, and Profitability!

Video: www.summa.com/video/twin



Video:
Scan the QR
code to watch
all the Summa
videos



SUMMA S ONE SERIES, MADE TO GROW AT YOUR BUSINESS' PACE

With the S One Series, Summa offers a future-proof and reliable cutting product line, designed based on years of experience, up-to-date techniques, and by listening carefully to the customers' cutting needs. Various types of roll stock such as flock, vinyl, and soft sheet materials can be processed efficiently and rapidly. A multitude of intelligent features combined with sleek ergonomics makes the S One Series the ideal vinyl cutter to grow with your business.



Summa S One Series

The One to Change the Game

The S One Series is the next step in growing your business and is designed with a focus on ergonomics and simplicity in usage. An extremely fast OPOS sensor system compensates for any deformation of the print and increases the speed by which registration marks are read. An efficient drag knife offers a pressure of 600 grams, enabling to cut laminated designs with ease. The sophisticated OPOS Xtra feature allows to process most intricate small sticker jobs with the highest accuracy.

Summa's legendary tracking system allows processing job after job. We provide a tracking guarantee of up to 8 m per job. The very durable titanium-coated grit rollers assure you can work intensively for many years with the best tracking system available on the market. Extra internal intelligence minimises human errors and operator intervention.

State-of-the-art engineering, sophisticated GoSign software, and versatile enhancement options have been combined to deliver unmatched performances. This is what makes the S One your first choice cutter where value and reliability are top of mind.

Key Features

The S One Series is available in different sizes and different configurations. However, all units have basic features in common, each contributing to the strength, reliability, and ease of use of the cutter.

Advanced Cutting Technology

The S One Series offers you leading-edge cutting technology without compromise. Up-to-date techniques deliver the highest contour-cutting accuracy for printed graphics. This makes the S One roll cutter a flexible and future-proof unit. The perfect companion for your business!

Ease of Use

Enjoy enhanced ease of use with integrated intelligent features, such as an intuitive touchscreen, blue mechanical parts for easy handling, and easy connectivity to most common computers in the market.

Summa GoSign Software

GoSign is your first choice cutting software designed for the Summa roll cutters. Manage your preferred workflow with great flexibility and automated cutting options, custom configuration of action sets, easy plug-ins for design programs, and much more.

Legendary performance

The S One Series is built on Summa's legendary performance, featuring an excellent material transport system to process the job accurately and continuously. The OPOS Xtra alignment method is designed to handle irregular material deformation over the length of the print by adding extra XY lines between the designs. This method is especially beneficial for the processing of small sticker jobs.

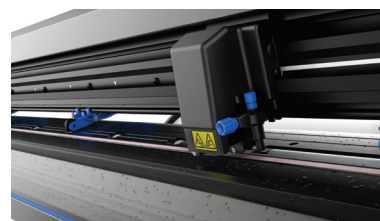

Summa S One Series line up

SUMMA S1 D60

The S1 D60 is Summa's smallest vinyl roll cutter and represents the ideal cutting solution for startup sign makers who want to automate their cutting workflow and extend their cutting applications. Though compact in size, this roll cutter delivers exceptional performance consistently.

Key Benefits

- Advanced cutting technology
- Ergonomic Design
- User-friendly features
- Latest alignment method
- Legendary tracking performance
- Connectivity: USB, Ethernet, and WiFi (region-dependent)
- Summa GoSign software
- Desktop cutter
- Automation through PostNet Barcode
- Optional stand / basket
- Optional Tray One sheet feeder
- Ideal for media up to 60cm wide



Technical Specifications

Model	S1 D60	
Dimensions	97 x 40.6 x 30.4 cm	
Media Width	7.9 to 70.5 cm	
Max. Working Width Oversized Mode*	59 cm x 50 m 65 cm x 50 m 'Oversized' mode allows a wider cutting area: +/-6 cm	
Alignment Type	<ul style="list-style-type: none">• OPOS X - OPOS Xtra• Barcode job recognition	<ul style="list-style-type: none">• Up to 2 x 64 marks on the X-line• Y-Line compensation
Tracking Performance	8 m max. within guaranteed specifications for media less than 762 mm	4 m max. within guaranteed specifications for media larger than 762 mm
Media Thickness	0.05 mm to 0.25 mm / 0.8 mm with optional sandblast knife	
Accuracy	0.2% of move or 0.25 mm, whichever is greater	
Speed	Up to 1131 mm/s diagonal	
Acceleration	Up to 3 G diagonal	
Knife Pressure	0 to 600 gr	
Other Features	FlexCut (cutting through)	
Connectivity	Ethernet, USB, WiFi (region dependent)	
Power Requirements	100-240 VAC, 50/60 Hz	
Included Software	Summa GoSign Software, Summa Cutter Control / Plug-in: Illustrator, CorelDraw, MacSign	
Cutting Technology	Drag knife	
*In 'Oversized' mode the tracking performance is no longer guaranteed.		

Key Features

The S1 D60 is the perfect choice for starters and professionals alike. It is compact, lightweight, and adored by flex and flock users and for label(stock) cutting.

This device can be easily configured to suit your needs with the stand and/or basket options. Maximise precision and quality by opting for factory-installed extra pinch rollers that ensure your media stays perfectly flat.

For automation enthusiasts, pair it with our [Tray One sheet feeder](#) (p.16) for seamless, automated sheet feeding and enjoy exceptional performance, consistently.



SUMMA S1 D120

The S1 D120 is the ideal cutting solution for intermediate-size cutting jobs. It excels in cutting coloured foils and printed media, perfect for sign makers that want to automate and level up their cutting workflow. The S One Series is your first choice, where value and reliability are top of mind.

Key Benefits

- Advanced cutting technology
- Ergonomic design
- User-friendly features
- Latest alignment method
- Legendary tracking performance
- Connectivity: USB, Ethernet, and WiFi (region-dependent)
- Summa GoSign software
- Stand included
- Basket included
- Automation through PostNet Barcode
- Ideal for media up to 123.5cm wide

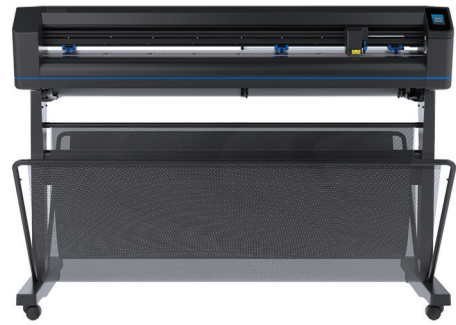

Technical Specifications

Model	S1 D120	
Dimensions	161.5 x 70.4 x 111.2 cm	
Media Width	13.3 to 135 cm	
Max. Working Width Oversized Mode*	123.5 cm x 50 m 129.5 cm x 50 m 'Oversized' mode allows a wider cutting area: +/-6 cm	
Alignment Type	<ul style="list-style-type: none"> • OPOS X - OPOS Xtra • Barcode job recognition 	<ul style="list-style-type: none"> • Up to 2 x 64 marks on the X-line • Y-Line compensation
Tracking Performance	8 m max. within guaranteed specifications for media less than 762 mm	4 m max. within guaranteed specifications for media larger than 762 mm
Media Thickness	0.05 mm to 0.25 mm / 0.8 mm with optional sandblast knife	
Accuracy	0.2% of move or 0.25 mm, whichever is greater	
Speed	Up to 1131 mm/s diagonal	
Acceleration	Up to 3 G diagonal	
Knife Pressure	0 to 600 gr	
Other Features	FlexCut (cutting through)	
Connectivity	Ethernet, USB, WiFi (region dependent)	
Power Requirements	100-240 VAC, 50/60 Hz	
Included Software	Summa GoSign Software, Summa Cutter Control / Plug-in: Illustrator, CorelDraw, MacSign	
Cutting Technology	Drag knife	
*In 'Oversized' mode the tracking performance is no longer guaranteed.		

Key Features

Discover the ultimate cutting companion for a wide range of jobs – the S1 D120 strikes the ideal intermediate size.

This game changer adored by sign-making and graphics professionals proves to be especially suitable for processing coloured vinyl to craft striking signs, temporary displays, and tarpaulins.

Enjoy its efficiency, ease of use, and ability to bring your creative visions to life with utmost accuracy.



SUMMA S1 D140 (FX)

Searching for an intermediate-sized cutting solution? Look no further than the S1 D140. Specializing in print and cut jobs, it's ideal for sign makers who want to automate and streamline their workflow. With the S One Series, you can count on value and reliability every time.

Key Benefits

- Advanced cutting technology
- Ergonomic design
- User-friendly features
- Latest alignment method
- Legendary tracking performance
- Connectivity: USB, Ethernet, and WiFi (region-dependent)
- Summa GoSign software
- Stand included
- Basket included
- Automation through PostNet Barcode
- FX designed for common (or popular) media widths
- Ideal for media up to 138.5cm wide
- Twin X functionality

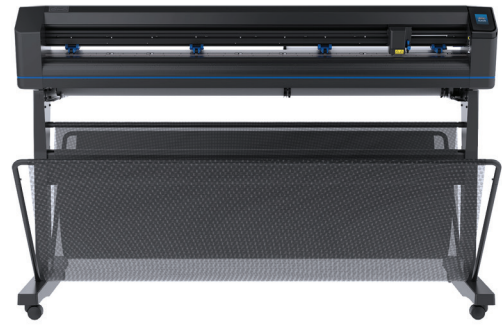

Technical Specifications

Model	S1 D140	
Dimensions	176.5 x 70.4 x 111.2 cm	
Media Width	18.7 to 150 cm	
Max. Working Width Oversized Mode*	138.5 cm x 50 m 144.5 cm x 50 m 'Oversized' mode allows a wider cutting area: +/-6 cm	
Alignment Type	<ul style="list-style-type: none"> • OPOS X - OPOS Xtra • Barcode job recognition 	<ul style="list-style-type: none"> • Up to 2 x 64 marks on the X-line • Y-Line compensation
Tracking Performance	8 m max. within guaranteed specifications for media less than 762 mm	4 m max. within guaranteed specifications for media larger than 762 mm
Media Thickness	0.05 mm to 0.25 mm / 0.8 mm with optional sandblast knife	
Accuracy	0.2% of move or 0.25 mm, whichever is greater	
Speed	Up to 1131 mm/s diagonal	
Acceleration	Up to 3 G diagonal	
Knife Pressure	0 to 600 gr (D140 FX: 0 to 400 gr)	
Other Features	FlexCut (cutting through)	
Connectivity	Ethernet, USB, WiFi (region dependent)	
Power Requirements	100-240 VAC, 50/60 Hz	
Included Software	Summa GoSign Software, Summa Cutter Control / Plug-in: Illustrator, CorelDraw, MacSign	
Cutting Technology	Drag knife	
*In 'Oversized' mode the tracking performance is no longer guaranteed.		

Key Features

Experience seamless efficiency as the S1 D140 (FX) effortlessly handles diverse media, delivering precision-cut graphics with unmatched ease.

Combined with the time-saving barcode workflow automation for Print&Cut jobs, user intervention is drastically reduced, allowing for uninterrupted productivity. Unlock the full potential of automation and witness the remarkable impact on your workflow, making every project a breeze.

The **FX model** has fixed pinch roller positions, meaning any media size can be loaded but margins cannot be minimised. It is perfectly suited for customers whose primary focus is not on the direct-cut method and who have a moderate workload.



SUMMA S1 D160

The S1 D160 is Summa's largest roll cutter size, offering great flexibility in the cutting workflow with the ability to process many job sizes. All S One models represent the ideal cutting solution for sign makers who want to automate and level up their cutting workflow. The S One Series is your first choice, where value and reliability are top of mind.

Key Benefits

- Drag cutting technology
- Ergonomic design
- User-friendly features
- Latest alignment method
- Legendary tracking performance
- Connectivity: USB, Ethernet, and WiFi (region-dependent)
- Summa GoSign software
- Stand included
- Basket included
- Automation through PostNet Barcode
- Ideal for media up to 158cm wide
- Twin X functionality

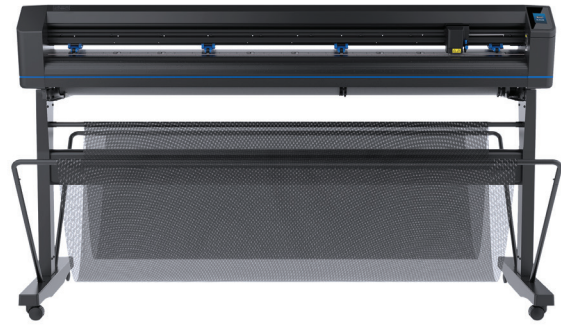

Technical Specifications

Model	S1 D160	
Dimensions	196 x 70.4 x 111.2 cm	
Media Width	18.7 to 169 cm	
Max. Working Width Oversized Mode*	158 cm x 50 m 164 cm x 50 m 'Oversized' mode allows a wider cutting area: +/-6 cm	
Alignment Type	<ul style="list-style-type: none">• OPOS X - OPOS Xtra• Barcode job recognition	<ul style="list-style-type: none">• Up to 2 x 64 marks on the X-line• Y-Line compensation
Tracking Performance	8 m max. within guaranteed specifications for media less than 762 mm	4 m max. within guaranteed specifications for media larger than 762 mm
Media Thickness	0.05 mm to 0.25 mm / 0.8 mm with optional sandblast knife	
Accuracy	0.2% of move or 0.25 mm, whichever is greater	
Speed	Up to 1131 mm/s diagonal	
Acceleration	Up to 3 G diagonal	
Knife Pressure	0 to 600 gr	
Other Features	FlexCut (cutting through)	
Connectivity	Ethernet, USB, WiFi (region dependent)	
Power Requirements	100-240 VAC, 50/60 Hz	
Included Software	Summa GoSign Software, Summa Cutter Control / Plug-in: Illustrator, CorelDraw, MacSign	
Cutting Technology	Drag knife	
*In 'Oversized' mode the tracking performance is no longer guaranteed.		

Key Features

The Summa S1 D160 is the ultimate solution for large-format projects. With its impressive ability to handle media up to 158cm wide, it ensures flawless precision on a grand scale.

Pair it with our F1612 Flatbed cutter to harness the full potential of the **Twin X functionality**, revolutionizing your Print&Cut jobs. Add the barcode workflow to the mix, and you've got the most efficient and productive workflow available.

Experience efficiency and versatility like never before, unleashing the boundless potential of your creative endeavours.



TRAY ONE SHEET FEEDER FOR S1 D60

The Tray One sheet feeder enhances automation, facilitates media handling, and saves the roll cutter operator a lot of time. Tray One is compatible and retrofittable with the S1 D60 model from the Summa S One Series.

Combining our desktop roll cutters with a sheet feeder not only benefits large-volume industries but also small-volume businesses, such as copy shops and retailers. By using Tray One, each copy/sheet will be cut straightforwardly and easily. Sheet after sheet. For hours in a row.

Efficient Cutting of Labels and Sheets

Tray One represents an efficient label and sheet solution for industries small and large, including many advantages that contribute to the streamlining of your Print&Cut workflow:

- Efficient workflow options with Summa GoSign software.
- Support of common copier sizes: A4, A3 SRA3, SA3 Letter, Tabloid, and Tabloid Extra.
- Direct cutting of loose sheets.
- Automatic contour cutting of printed sheets (OPOS/OPOS Barcode).
- The printer can work with full sheets whilst the stickers can be cut afterwards. So, the risk of pre-cut labels coming off in the printer is eliminated.



TECHNICAL SPECIFICATIONS

Model	S1 D60	S1 D120	S1 D140	S1 D160
Dimensions	97 x 40.6 x 30.4 cm	161.5 x 70.4 x 111.2 cm	176.5 x 70.4 x 111.2 cm	196 x 70.4 x 111.2 cm
Media Width	7.9 to 70.5 cm	13.3 to 135 cm	18.7 to 150 cm	18.7 to 169 cm
Max. Working Width Oversized Mode*	59 cm x 50 m 65 cm x 50 m	123.5 cm x 50 m 129.5 cm x 50 m	138.5 cm x 50 m 144.5 cm x 50 m	158 cm x 50 m 164 cm x 50 m
	'Oversized' mode allows a wider cutting area: +/-6 cm			
Pinch Rollers	2	3	4 (3 for FX)	4
Alignment Type	<ul style="list-style-type: none"> OPOS X - OPOS Xtra Barcode job recognition 		<ul style="list-style-type: none"> Up to 2 x 64 marks on the X-line Y-Line compensation 	
Tracking Performance	8 m max. within guaranteed specifications for media less than 762 mm 4 m max. within guaranteed specifications for media larger than 762 mm			
Media Thickness	0.05 mm to 0.25 mm / 0.8 mm with optional sandblast knife			
Accuracy	0.2% of move or 0.25 mm, whichever is greater			
Speed	Up to 1131 mm/s diagonal			
Acceleration	Up to 3 G diagonal			
Knife Pressure	0 to 600 gr			
Other Features	FlexCut (cutting through)			
Connectivity	Ethernet, USB, WiFi (region dependent)			
Power Requirements	100-240 VAC, 50/60 Hz			
Included Software	Summa GoSign Software, Summa Cutter Control / Plug-in: Illustrator, CorelDraw, MacSign			
Cutting Technology	Drag knife			
*In 'Oversized' mode the tracking performance is no longer guaranteed.				



S1 D60

S1 D120

S1 D140

S1 D140 FX

S1 D160

NOTES

**NEW
RELEASE**

SUMMA S CLASS 3 SERIES, DESIGNED FOR TOP PERFORMANCE

The S Class 3 tangential and drag-knife cutters feature first-class engineering and advanced cutting technology. The new S Class 3 series is crafted to cater to the needs of true professionals who demand nothing short of top-notch performance, pinpoint precision, and unparalleled versatility in their work. With its advanced technology, intuitive software GoSign, durable construction, and timesaving features, they surpass even the most demanding user expectations.

Leave nothing to chance and enjoy our leading-edge contour cut excellence!



Summa S Class 3 Series

Level Up with Advanced Cutting Technology

The Summa S Class 3 not only masters precision and versatility, but it also proves to be a durable workhorse built to last. Constructed with premium materials, it can withstand heavy use while delivering consistent, high-quality results day in, day out.

From vinyl cutting to precise digital die-cutting and plotting on various materials, the S Class 3 is a true do-it-all cutter, catering to a myriad of creative needs. It is your ultimate choice for handling expensive foils and valuable vinyl prints with precision and reliability. Prepare to elevate your cutting endeavours to new heights of excellence with European craftsmanship. Place your trust in the S Class 3 cutters, and you'll never look back.

Key Features

S Class 3 tangential and drag-knife cutters pave the way for cutting excellence through an efficient and productive workflow. A broad range of integrated and optional features take your cutting workflow and operator comfort to the next level.

True Tangential Cutting Technology

The highly-engineered tangential cutting heads on the S Class 3T Series have a unique motorised knife, allowing the cutters to achieve unparalleled accuracy and precision down to the smallest details. Our True Tangential cutting technology even handles heavy sandblasts, paint masks, and reflective materials.

Smart Object Sorting and Panelling

The Smart Object Sorting feature is designed to select the most optimal starting point for cutting objects, every single time. In addition, the unique Smart Panelling function improves cutting accuracy and simplifies post-processing. When panelling is, e.g., set to 40cm, all objects within this range are cut at once.

Summa GoSign Software

Our powerful in-house GoSign software allows you to manage your preferred workflow straightforwardly and with great flexibility.

Fast and Accurate Cutting with OPOS CAM (S Class 3 TC)

The new camera is more performant with even faster recognition abilities thanks to automatic data processing in the cutter instead of the external software. It allows you to excel with extremely fast and precise cutting of short or long-run contour-cutting jobs.

Dual Head Functionality (S Class 3 TC)

The S Class 3 TC models are the most advanced cutters of the S3 Series. Their high-precision cutting head can now carry two tools at once. This allows you to cut and crease or cut and draw without changing tools.

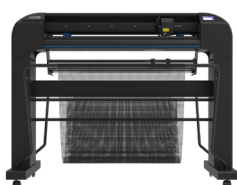
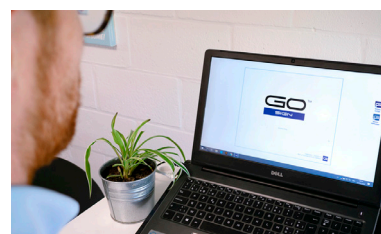
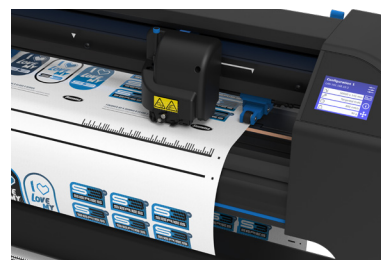

S3 TC75

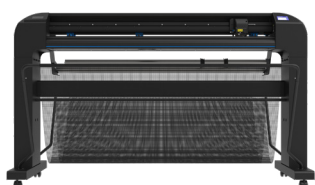

S3 D120

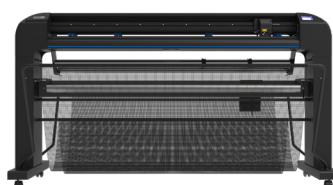

S3 D140

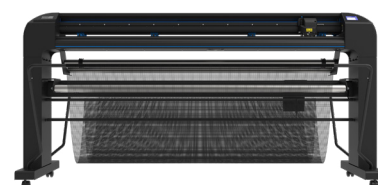

S3 TC160

SUMMA S3 75

The smallest model in the S Class 3 Series is the ideal cutting solution for a startup sign maker who opts for cutting excellence and wants to take their production to the next level.

Key Benefits

- Advanced cutting technology
- Ergonomic design
- User-friendly features
- Latest alignment method
- Legendary tracking performance
- Connectivity options
- Summa GoSign software
- Combining Cut & Crease and OPOS (TC)
- Tangential or drag knife technology
- Indicator light
- Camera or sensor recognition of registration marks
- Barcode functionality for automation



Technical Specifications

Model	S3 75	
Dimensions	141 x 69 x 111 cm	
Media Width	6 to 84 cm	
Max. Working Width	74.2 cm x 50 m 'Oversized' mode allows a wider cutting area: +/-7 cm	
Alignment Type	<ul style="list-style-type: none"> • OPOS X - OPOS Xtra • OPOS - CAM (factory upgrade) • Barcode job recognition 	<ul style="list-style-type: none"> • Up to 2 x 64 marks on the X-line • Y-Line compensation
Tracking Performance	12 m max. within guaranteed specifications for media less than 760 mm	4 m max. within guaranteed specifications for media larger than 760 mm
Media Thickness	0.05 mm to 0.25 mm / Up to 0.8 mm with sandblast drag knife / Up to 1.2 mm with sandblast tangential knife	
Accuracy	0.2% of move or 0.25 mm, whichever is greater	
Speed	Up to 1440 mm/s diagonal	
Acceleration	Up to 4.25 G diagonal	
Knife Pressure	Drag Knife: Up to 400 grams / Tangential Knife: Up to 1000 grams	
Extra Pen or Creaser Pressure	Up to 1000 grams	
Other Features	FlexCut (cutting through)	
Connectivity	Ethernet, USB, WIFI	
Power Requirements	100-120 / 220-240 VAC, 50/60 Hz, 85 VA maximum	
Included Software	Summa GoSign Software, Summa Cutter Control / Plug-in: Illustrator, CorelDraw, MacSign	
Cutting Technology	Drag knife / Tangential knife	
Dual Head	Creasing tool / Fibre pen	
*In 'Oversized' mode the tracking performance is no longer guaranteed.		

Key Features

The Summa S3 75 is the smallest roll cutter in the S3 series. It's thoughtfully designed to cater to every user's needs, from beginners to seasoned professionals. With a capability to handle media up to 74cm (+7cm in oversized mode), it's perfectly tailored for flex and flock users, as well as label-cutting professionals.

Precision and quality can be maximised by opting for the tangential knife, allowing you to achieve razor-sharp edges and immaculate results with ease.

The TC head is the perfect solution for short-run crease and cut applications sheets up to A1 and B1. The S3 75 helps you elevate your precision, efficiency, and productivity.



SUMMA S3 120

This mid-size cutter in the S Class 3 Series offers more versatility in cutting applications. With unparalleled technology and reliability, this cutter delivers leading-edge performance and precision. Fast and straightforwardly.

Key Benefits

- Advanced cutting technology
- Ergonomic design
- User-friendly features
- Latest alignment method
- Legendary tracking performance
- Connectivity options
- Summa GoSign software
- Tangential or drag knife technology
- Indicator light
- Camera or sensor recognition of registration marks
- Barcode functionality for automation

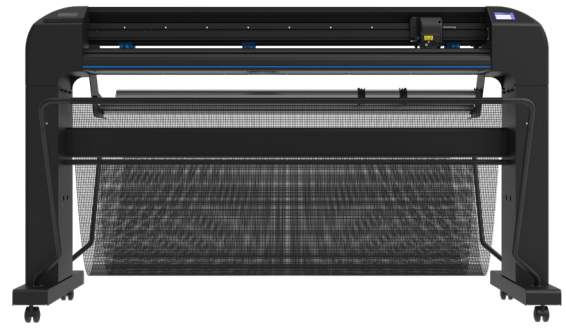

Technical Specifications

Model	S3 120	
Dimensions	187 x 69 x 111 cm	
Media Width	11.4 to 130 cm	
Max. Working Width	120 cm x 50 m 'Oversized' mode allows a wider cutting area: +/-7 cm	
Alignment Type	<ul style="list-style-type: none"> • OPOS X - OPOS Xtra • Barcode job recognition 	<ul style="list-style-type: none"> • Up to 2 x 64 marks on the X-line • Y-Line compensation
Tracking Performance	12 m max. within guaranteed specifications for media less than 760 mm	4 m max. within guaranteed specifications for media larger than 760 mm
Media Thickness	0.05 mm to 0.25 mm / Up to 0.8 mm with sandblast drag knife / Up to 1.2 mm with sandblast tangential knife	
Accuracy	0.2% of move or 0.25 mm, whichever is greater	
Speed	Up to 1440 mm/s diagonal	
Acceleration	Up to 4.2 G diagonal	
Knife Pressure	Drag Knife: Up to 400 grams / Tangential Knife: Up to 1000 grams	
Other Features	FlexCut (cutting through)	
Connectivity	Ethernet, USB, WIFI	
Power Requirements	100-120 / 220-240 VAC, 50/60 Hz, 85 VA maximum	
Included Software	Summa GoSign Software, Summa Cutter Control / Plug-in: Illustrator, CorelDraw, MacSign	
Cutting Technology	Drag knife / Tangential knife	
*In 'Oversized' mode the tracking performance is no longer guaranteed.		

Key Features

The Summa S3 120 is a cutting-edge mid-size model designed to handle media up to 120cm (+7cm in oversized mode), making it the ideal choice for medium-scale projects, such as non-prismatic traffic signs and internal signage.

The roll cutter is equipped with either a drag or tangential knife, creating the sharpest corners and edges, guaranteeing a meticulous and flawless result. Its upgraded cutting power and fast throughput make this powerhouse the perfect addition to your workflow, increasing your Productivity, Performance, and Profitability!

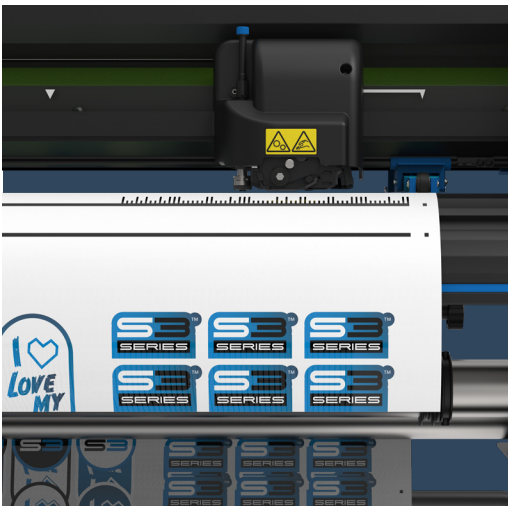

SUMMA S3 140

This mid-size cutter in the S Class 3 Series enables a larger media width offering more versatility in the cutting applications. With unparalleled technology and reliability, this cutter delivers leading-edge performance and precision. Fast and straightforwardly.

Key Benefits

- Advanced cutting technology
- Ergonomic design
- User-friendly features
- Latest alignment method
- Legendary tracking performance
- Connectivity options
- Summa GoSign software
- Tangential or Drag knife technology
- Indicator light
- Advanced throughput functionality
- Camera or Sensor recognition of registration marks
- Barcode functionality for automation
- Twin X functionality
- Roll-up system

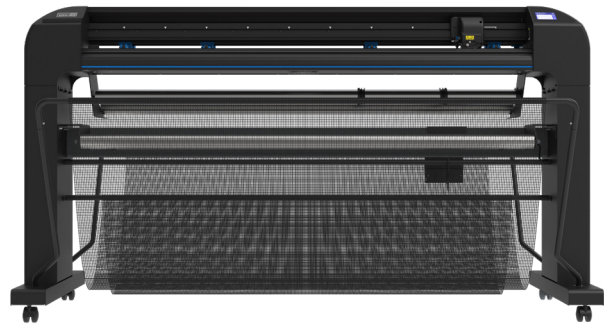

Technical Specifications

Model	S3 140	
Dimensions	202 x 69 x 111 cm	
Media Width	17 to 145 cm	
Max. Working Width	135 cm x 50 m 'Oversized' mode allows a wider cutting area: +7 cm	
Alignment Type	<ul style="list-style-type: none"> • OPOS X - OPOS Xtra • Barcode job recognition 	<ul style="list-style-type: none"> • Up to 2 x 64 marks on the X-line • Y-Line compensation
Tracking Performance	12 m max. within guaranteed specifications for media less than 760 mm	4 m max. within guaranteed specifications for media larger than 760 mm
Media Thickness	0.05 mm to 0.25 mm / Up to 0.8 mm with sandblast drag knife / Up to 1.2 mm with sandblast tangential knife	
Accuracy	0.2% of move or 0.25 mm, whichever is greater	
Speed	Up to 1440 mm/s diagonal	
Acceleration	Up to 4.2 G diagonal	
Knife Pressure	Drag Knife: Up to 400 grams / Tangential Knife: Up to 1000 grams	
Other Features	FlexCut (cutting through)	
Connectivity	Ethernet, USB, WIFI	
Power Requirements	100-120 / 220-240 VAC, 50/60 Hz, 85 VA maximum	
Included Software	Summa GoSign Software, Summa Cutter Control / Plug-in: Illustrator, CorelDraw, MacSign	
Cutting Technology	Drag knife / Tangential knife	
*In 'Oversized' mode the tracking performance is no longer guaranteed.		

Key Features

The Summa S3 140 offers even more cutting versatility and endless creative possibilities. Tackle larger projects with ease as it effortlessly handles media up to 135cm (+7cm in oversized mode). Combining the barcode functionality with the best-in-class OPOS sensor lets you experience next-level productivity and precision. It ensures a faster and even more precise reading speed, increasing productivity while keeping the throughput reliable.

The roll cutter also contains the latest alignment methods and advanced cutting techniques to ensure flawless edges and precision-cut graphics. The cutter operates with seamless efficiency, elevating your productivity and streamlining your workflow.

To streamline your workflow even more, you can opt for the roll-up unit, which rolls up your processed materials again instead of dropping them in the basket.



SUMMA S3 160

The largest roll cutter size in the S Class 3 Series is tailored to the professional user who wants maximum flexibility in the possible applications and desires the most advanced technology and features. Rely on leading-edge cutting performance and cutting excellence with the S Class 3.

- Connectivity options
- Summa GoSign software
- Combining Cut & Crease and OPOS (TC)
- Tangential or Drag knife technology
- Indicator light
- Advanced throughcut functionality
- Camera or Sensor recognition of registration marks
- Barcode functionality for automation
- Twin X functionality
- Roll-up system

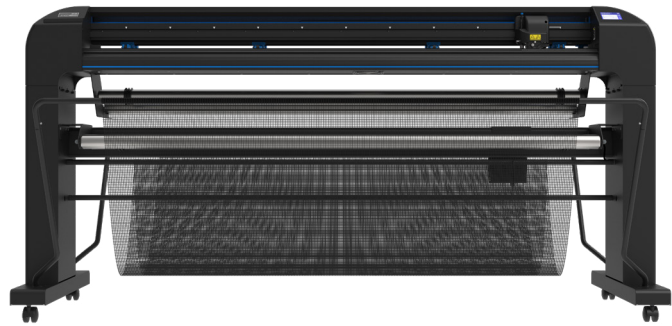

Technical Specifications

Model	S3 160	
Dimensions	225 x 69 x 111 cm	
Media Width	17 to 168 cm	
Max. Working Width	158 cm x 50 m 'Oversized' mode allows a wider cutting area: +/7 cm	
Alignment Type	<ul style="list-style-type: none"> • OPOS X - OPOS Xtra • OPOS - CAM (factory upgrade) • Barcode job recognition 	<ul style="list-style-type: none"> • Up to 2 x 64 marks on the X-line • Y-Line compensation
Tracking Performance	12 m max. within guaranteed specifications for media less than 760 mm	4 m max. within guaranteed specifications for media larger than 760 mm
Media Thickness	0.05 mm to 0.25 mm / Up to 0.8 mm with sandblast drag knife / Up to 1.2 mm with sandblast tangential knife	
Accuracy	0.2% of move or 0.25 mm, whichever is greater	
Speed	Up to 1440 mm/s diagonal	
Acceleration	Up to 4.2 G diagonal	
Knife Pressure	Drag Knife: Up to 400 grams / Tangential Knife: Up to 1000 grams	
Extra Pen or Creaser Pressure	Up to 1000 grams	
Other Features	FlexCut (cutting through)	
Connectivity	Ethernet, USB, WIFI	
Power Requirements	100-120 / 220-240 VAC, 50/60 Hz, 85 VA maximum	
Included Software	Summa GoSign Software, Summa Cutter Control / Plug-in: Illustrator, CorelDraw, MacSign	
Cutting Technology	Drag knife / Tangential knife	
Dual Head	Creasing tool / Fibre pen	
*In 'Oversized' mode the tracking performance is no longer guaranteed.		

Key Features

The S3 160 is perfect for professionals that want maximum versatility and productivity. With the capability to handle media up to 158cm (+7cm in oversized mode), it's ideal for large-format projects. Equipped with advanced cutting technology and either a drag or tangential knife, it allows for more control and pressure, ensuring precision and efficiency in every cut.

Unlock the power of full automation with the Summa S3 160. By simply placing a printer in front of the roll cutter, you can achieve seamless transitions from printing to cutting without any intervention. Moreover, by opting for the roll-up unit, you can neatly roll up the processed material instead of letting it fall into the basket.

Need even more cutting power? The **Twin X functionality** offers the ultimate solution by seamlessly integrating the Summa S3 160 with the F1612 flatbed cutter. This dynamic duo will optimize your workflow efficiency and elevate your business to unparalleled heights.



S CLASS 3 CUTTING TECHNOLOGIES

In the ever-evolving world of cutting, one technology doesn't fit every bill. That's why having a range of cutting technologies at your fingertips is paramount.

The S Class 3 has three different heads available: the D series, specifically for drag knife technology, the T series, for tangential knife technology, and the TC Series, which combines the knife and fibre pen or knife and creasing tool.

Various tools are also available to help cut, crease, and draw on your materials. As well as a tray tool to keep everything organised, to make your workflow as efficient as possible.

Choose your path to perfection with our D series, T series, or TC series cutting head, each with its distinct advantages.



S Class 3 D Series
Drag Knife Technology

Summa S3 D Series roll cutters are specifically designed for high-volume cutting environments. They unite legendary S Class power and precision with an efficient and affordable drag knife cutting head. Boasting an astonishing array of industry-first innovations and built-in capabilities, the S3 D Series is a do-it-all dynamo with the resilience to perform day in day out.



S Class 3 T Series
Tangential Knife Technology

The Summa S Class 3 T Series combines S Class power and precision with a state-of-the-art True Tangential cutting head. Coupled with an astonishing array of innovations and built-in capabilities, this cutter offers you the best in roll cutting.



S Class 3 TC Series
Performance Cutting Head & OPOS Camera

The TC models are equipped with the most advanced cutting head in the Roll Cutter Series. The high-precision cutting head can now carry two tools, allowing FlexCut and kiss-cut in combination with creasing or drawing. All without changing tools.



S Class 3 TC Series Specifics

The S Class 3 TC models feature an even more performant camera. Thanks to automatic data processing in the cutter instead of external software, the registration of marks is faster than ever before. Combined with our powerful True Tangential Cutting Technology and knife pressure of up to 1000 gr, these models are designed to deliver true cutting excellence.

- Unique True Tangential cutting technology
- Higher accuracy by placing 'in-field' registration marks
- Accurate fixed-size cutting with Fixed-size mode
- Job segmentation to preserve the best tracking performance
- Mark registration about 10 times faster than any other light sensor
- Custom camera profile to process challenging media types
- Available as a factory upgrade for Summa S Class 3 T75 & T160
- Features Dual Head technology: knife + fibre pen or knife + creasing tool

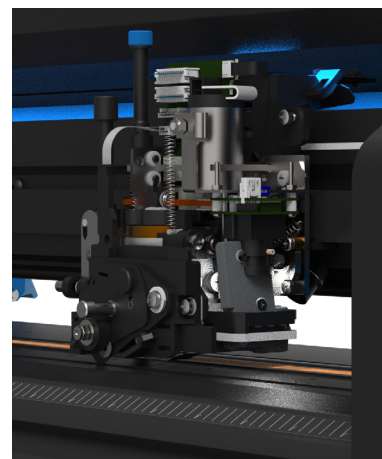

S Class 3 TOOLS

Different tools can be inserted in the cutting head to achieve different cutting effects and accommodate various materials. Cutting, creasing, and drawing on your materials has never been this easy. Get the most out of your S Class 3 with the following tools:



- Ballpoint pen
- Fibre pen
- Tangential knife
- Drag knife
- Creasing tool

Thanks to the **Dual Head functionality**, the cutter can carry a knife and fibre pen or a knife and creasing tool at the same time. It allows you to work as fast and efficiently as possible.

Additionally, a tool tray is provided. It offers a secure storage space for tools not currently in use, conveniently within reach at the back of the cutter for when they're needed.



S CLASS 3 FEATURES

G-Performance Mode

G-performance boosts your production speed on the S Class 3 roll cutters by up to 40%, depending on the type of cutting job. Its impact is especially noticeable on a faster reading of the registration marks and when cutting wider substrates. As a result, default jobs are handled much faster than average. G-performance is standard on all S Class 3 cutters and is perfect for users who want to step up their yield and process jobs that can handle higher-than-average speeds.

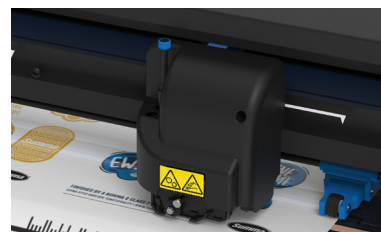

Ease of Use

Discover improved ease of use with a blue, green, orange, and red-lighted status bar. Additionally, swiftly identify adjustable components by their blue color. This is complemented by a strategically placed tool tray at the back for efficient operation.



BLUE status = Ready



GREEN status = Working



RED status = Error



ORANGE status = Lift pinch rollers

MEDIA HANDLING & OPTIONS

Larger Media Roll

The media roll on the cutter can now handle a diameter of 20cm and supports a roll weight of at least 45kg. This improvement is highly beneficial for print and cut applications, including laminated vinyl.

Servo-powered Roll-up System | S3 140 & S3 160

After finishing a job, the system will roll up the artwork neatly and prepare the machine for the next one. The integrated panelling feature splits long-length runs into shorter consecutive tasks, allowing to cut complete rolls unattended and deliver the output nicely rolled-up.



S CLASS 3 TECHNICAL SPECIFICATIONS

Model	S3 75	S3 120	S3 140	S3 160
Dimensions	141 x 69 x 111 cm	187 x 69 x 111 cm	202 x 69 x 111 cm	225 x 69 x 111 cm
Media Width	6 to 84 cm	11.5 to 130 cm	17 to 145 cm	17 to 168 cm
Max. Working Width Oversized Mode*	74.2 cm x 50 m	120 cm x 50 m	135 cm x 50 m	158 cm x 50 m
	'Oversized' mode allows a wider cutting area : +/- 7 cm*			
Pinch Rollers	2	3	4	4
Alignment Type	<ul style="list-style-type: none"> OPOS X - OPOS Xtra OPOS CAM : Factory upgrade on new Summa S Class 3 S75T and S160T 		<ul style="list-style-type: none"> Barcode job recognition Up to 2 x 64 marks on the X-line Y-Line compensation 	
Tracking Performance	Within +/- 0.1 mm on plots: <ul style="list-style-type: none"> up to 12 m long on rolls up to 760 mm wide* up to 4 m long on rolls over 760 mm wide* 			
Media Thickness	0.05 mm to 0.25 mm / Up to 0.8 mm with sandblast drag knife / Up to 1.2 mm with sandblast tangential knife			
Accuracy	0.2% of move or 0.25 mm, whichever is greater			
Speed	Up to 1440 mm/s diagonal			
Acceleration	Up to 4.2 G diagonal			
Knife Pressure	Drag Knife: Up to 400 grams / Tangential Knife: Up to 1000 grams			
Extra Pen or Creaser Pressure	Up to 1000 grams	-	-	Up to 1000 grams
Other Features	FlexCut (cutting through)			
Connectivity	Ethernet, USB, WIFI			
Power Requirements	100-120 / 220-240 VAC, 50/60 Hz, 85 VA maximum			
Included Software	Summa GoSign Software, Summa Cutter Control / Plug-in: Illustrator, CorelDraw, MacSign			
Cutting Technology	Drag Knife / Tangential knife			
*In 'Oversized' mode the tracking performance is no longer guaranteed.				

Summa Vinyl Cutters Comparison		S One FX Series	S One Series	S Class 3 D Series	S Class 3 T Series	S Class 3 TC Series
Maximum Media Width	60	-	70.5 cm	-	-	-
	75	-	-	84 cm	84 cm	84 cm
	120	-	135 cm	130 cm	130 cm	-
	140	142 cm	150 cm	145 cm	145 cm	-
	160	-	169 cm	168 cm	168 cm	168 cm
Cutting Technology	Drag Knife	Drag Knife	Drag Knife	True Tangential Knife	True Tangential Knife	
Opos alignment systems	✓	✓	✓	✓	✓	
Camera (USB)	-	-	-	-	✓	
Barcode Support	✓	✓	✓	✓	✓	
Roll-up	-	-	Optional	Optional	Optional	
Speed	**	***	*****	*****	*****	
Flexible Working Sizes	-	✓	✓	✓	✓	



SUMMA IN-HOUSE DEVELOPED SOFTWARE

The Summa GoSuite software platform is developed in-house and enables users to make the most of their print and cut workflow. With the Summa software, operators, designers, and business owners can easily process and analyse complex and high-volume jobs with great flexibility.

Rely on powerful software to maximise the use of your Summa cutting equipment.



Summa GoSign

GoSign is your first choice cutting software designed for the Summa roll cutters. It allows you to manage your preferred workflow with great flexibility. Enjoy automated cutting options, custom configuration of action sets, easy plug-ins for design programs, and more.



The GoSign software that comes with the machines includes many features to keep you going and will expand further in the future. For a small additional charge, you can purchase a Pro Pack, which provides even more functionality to accommodate your growing business.

- Modern interface
- Improved navigation
- Quick and intuitive
- Customised to your needs
- Standard available on website
- Pro Pack option available
- Windows-based

Build a Cutting Workflow to Your Preference

- Workflow automation, minimising operator intervention substantially.
- Increased flexibility with the option to cut directly from Adobe Illustrator or CorelDRAW.
- Material manager with your most commonly used materials and the possibility to add other material types along the way.
- Enhanced file compatibility, providing perfect synergy between hardware and software. Choose your preferred import method: by colour or by layer name.
- Availability of job log functionality, adding to the Summa roll cutters Industry 4.0 compatibility.
- Compatible with: DXF files, PLT files, and files from open-source design programs, such as Inkscape, and many more.
- Customise action sets tailored to your specific workflow needs.

TIP | Scan the QR code to watch the GoSign video on Summa's Youtube page.



GoSign Pro Pack

The optional GoSign Pro Pack offers advanced features such as barcode functionality, hot folder support, and import possibility of plot files. Similar to the standard GoSign software, the Pro Pack will be gradually expanded with new functionalities.

GoSign V3	GoSign V3 Pro Pack
Standard available on www.Summa.com	One-time Pro version purchase (395-995)
• All common functionalities specific to cutting programs: sorting, weeding box, multi-copy, ...	• All common functionalities specific to cutting programs: sorting, weeding box, multi-copy, ...
• Custom configuration of action sets	• Custom configuration of action sets
• Plug-ins for Adobe Illustrator and CorelDRAW	• Plug-ins for Adobe Illustrator and CorelDRAW
• Material Manager	• Material Manager
• Job log functionality	• Job log functionality
	• Camera recognition
	• Twin workflow
	• Barcode functionality
	• Hot folder job handling
	• Import of plot files

Product Registration

Summa recommends users register their products online. Upon registration, you can activate several features, such as the G-Performance, barcode, and more. In the registration form, you can also tick the box to receive our monthly newsletter. This way, you stay up to date with all of Summa's latest products and features that might complement your cutting equipment.

You can register all Summa products through the Summa website:
www.summa.com/support/product-registration

Inspiring Customer Stories

Customer stories capture an extensive range of end-user experiences. Experiences they gain by operating our Summa cutting equipment day in and day out. These stories will help you obtain a better understanding of why a Summa product might just be the game-changer you were looking for to bring your cutting workflow to the highest possible level.

Customer stories go beyond product leaflets, brochures, and other presentations. These real-life views and opinions from people in the field are the actual depiction of a product's benefits as shown in a true production area. Go ahead and read our blog! It's filled with inspiring customer stories about creating innovative and striking applications with our Summa equipment.

Blog: www.summa.com/blog

Testimonial | Stickers and Posters.com

"WE WOULDN'T BE ABLE TO RUN SUCH INCREDIBLE PRODUCTION WITHOUT THE SUMMA VINYL CUTTERS."

Company: Stickers and Posters.com

Core business:
One-off-design stickers

Challenge:
Fast cutting in high volume

Solution: 6 Summa S Class 2 T160

The Story | Each day, thousands of 'one-off-design' stickers go through production at lightning speed. Customer demand for stickers and posters increased dramatically along with the growing online market. A great business opportunity. So, Stickers and Posters decided to invest in 6! S Class 2 T160 cutters with True Tangential cutting technology to meet and exceed customer expectations. With this purchase, they can now finish out-of-the-box tasks, perfectly tailored to their customers' needs.

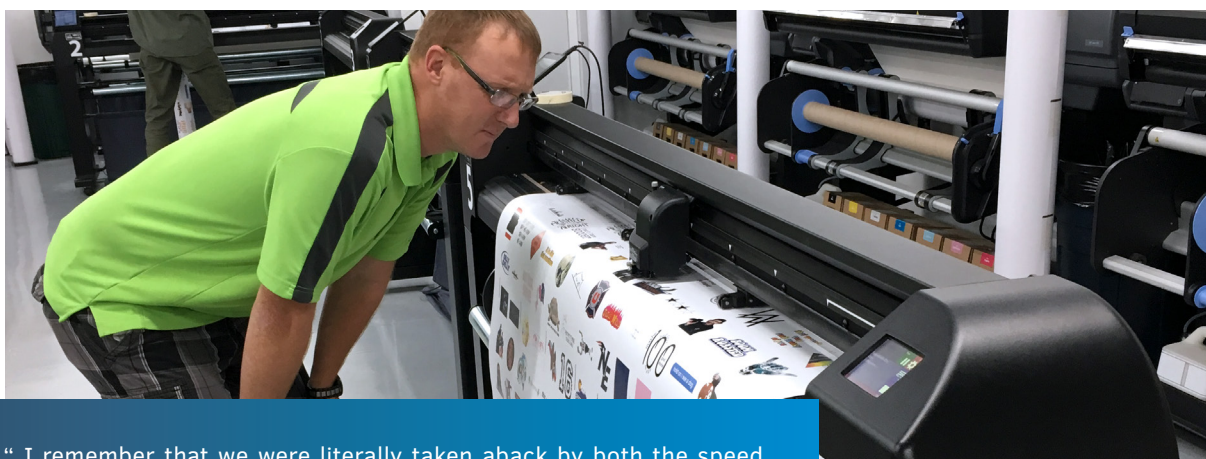

" I remember that we were literally taken aback by both the speed and incredible accuracy during the kiss-cutting process of the stickers on the S Class 2 vinyl cutter model. More so, we appreciate the ease of set-up and operation efficiency with the onboard tracking mechanism, combined with the ability to work continuously. So, ultimately we paired up a Summa S3T160 vinyl cutter to each of the HP latex printers to keep the workflow equal and smoothly flowing."

/ Stickers and Posters about investing in 6 Summa S Class 2 T160



S ONE SERIES™ S CLASS 3 SERIES™



**World renowned vinyl
and contour cutters**

Summa nv
Rochesterlaan 6
8470 Gistel
Belgium

www.summa.com

Summa America
8517 W. Washington Street
Suite 101
Indianapolis, IN 46231
USA

Follow us on LinkedIn | Facebook | Twitter | YouTube | #SummaFinish

Copyright 2024© Summa nv. Marketing Communications. Summa nv believes that all illustrations and specifications contained in this catalogue are correct at the time of publication. Summa nv reserves the right to make changes at any time, without notice. RevEN24.08 / All rights reserved

